

Huom !

Ennen hanan asentamista verkkoon, syöttävä vesijohtoputkisto on huuhdeltava juoksuttamalla vettä, jotta kaikki epäpuhtaudet poistuvat putkistosta. Takuu ei korvaa veden mukana tulleiden epäpuhtauksien aiheuttamia vikoja.

Puhdistukseen ei saa käyttää happoja tai liuottimia, eikä hankaavia aineita. Peruspuhdistukseen voi käyttää mietoon vesi/saippualliuokseen kostutettua pehmeää liinaa. Kalkkitahrat voidaan välttää kuivaamalla hana käytön jälkeen.

Note !

Before mounting the mixer it is recommended that pipelines are thoroughly flushed to remove any dirt particles. Failure to carry out this simple procedure can lead to damage of the mixer and invalidate the warranty.

Do not use abrasive/scouring agents or cleaning agents containing solvent or acid for cleaning. Clean the mixer with a soap and moist cloth only, then rinse off and wipe dry. You can avoid lime spots by drying the fitting each time it is used.

HANAN KIINNITTÄMINEN TYÖTASOON MOUNTING ON THE WORKTOP

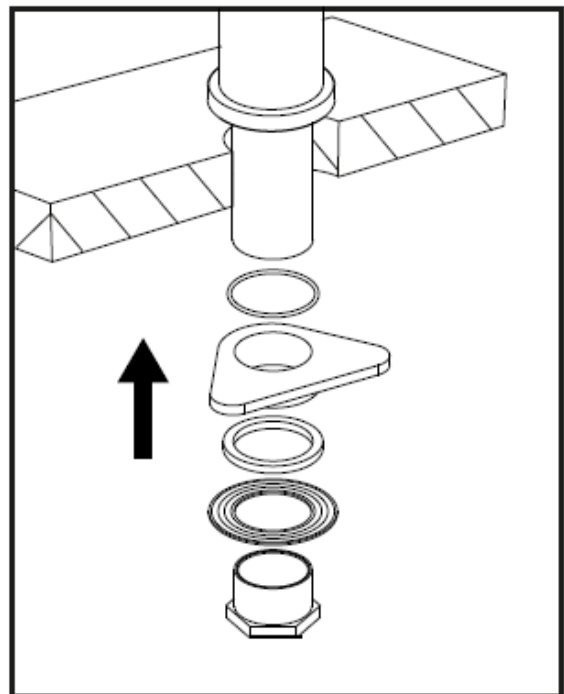
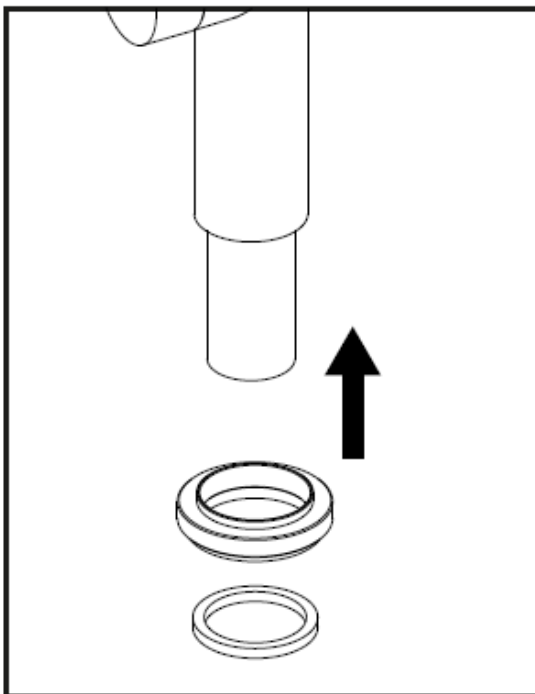

1)

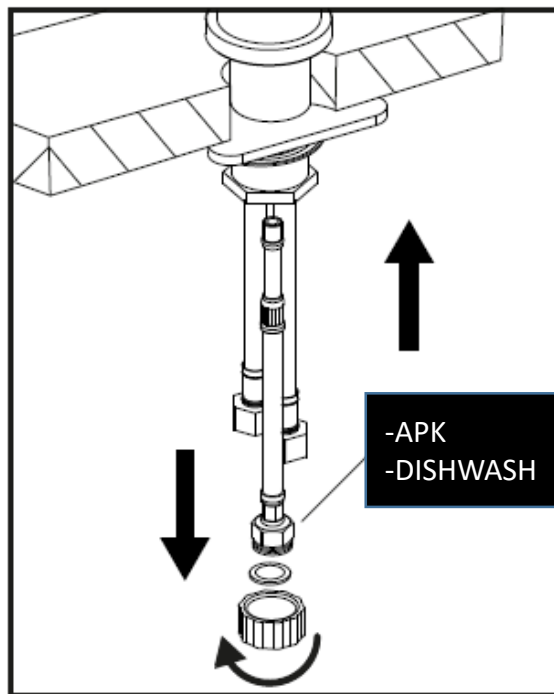
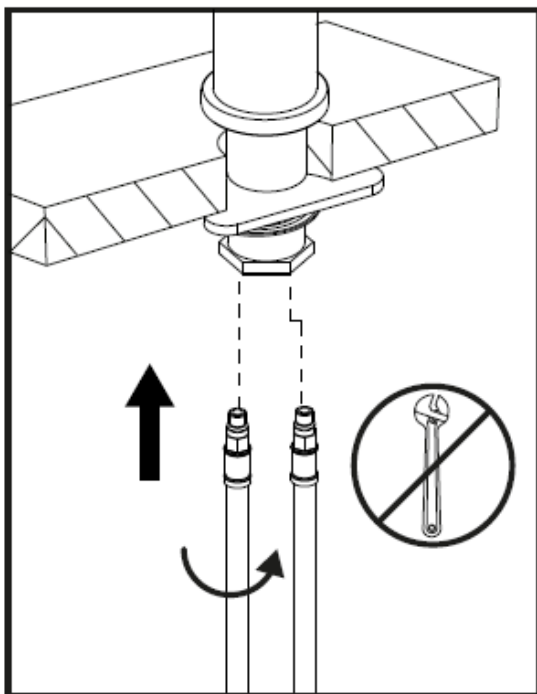

- 1) PUTKIEN ASENTAMINEN
- 2) SÄÄTÖSYLINTERI
- 3) APK-VENTTIILI

- 1) INSTALLING THE HOSES
- 2) CARTRIDGE
- 3) DISHWASH SHUT-OFF VALVE

2)

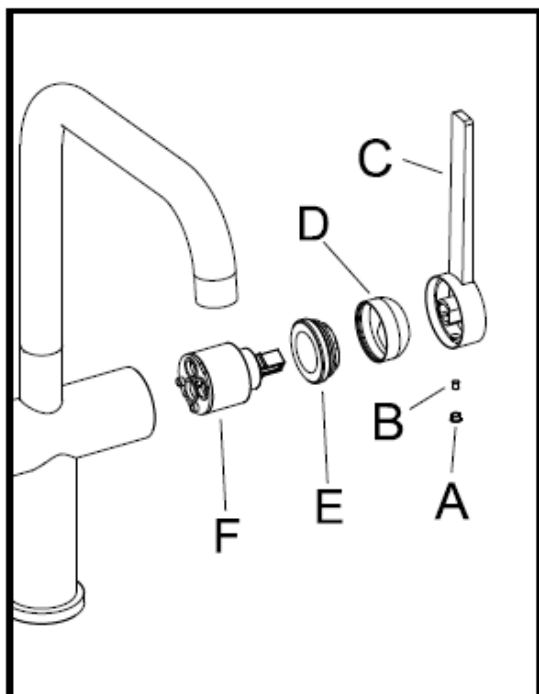

3)

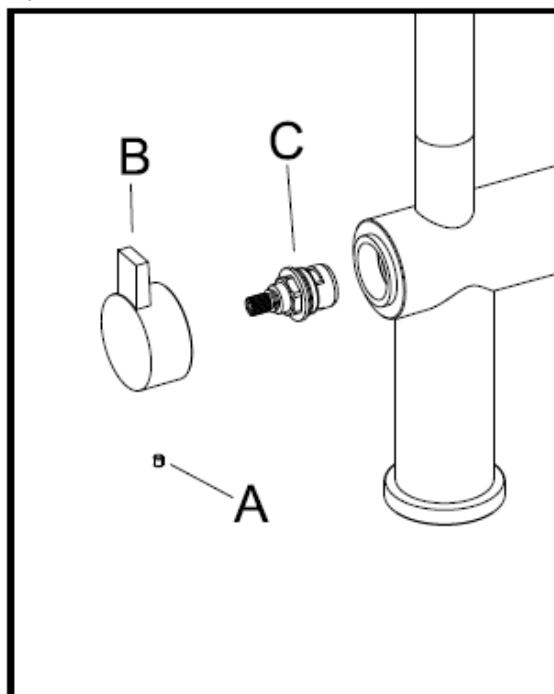

PORESUUTTIMEN VAIHTO
HOW TO REPLACE THE AERATOR

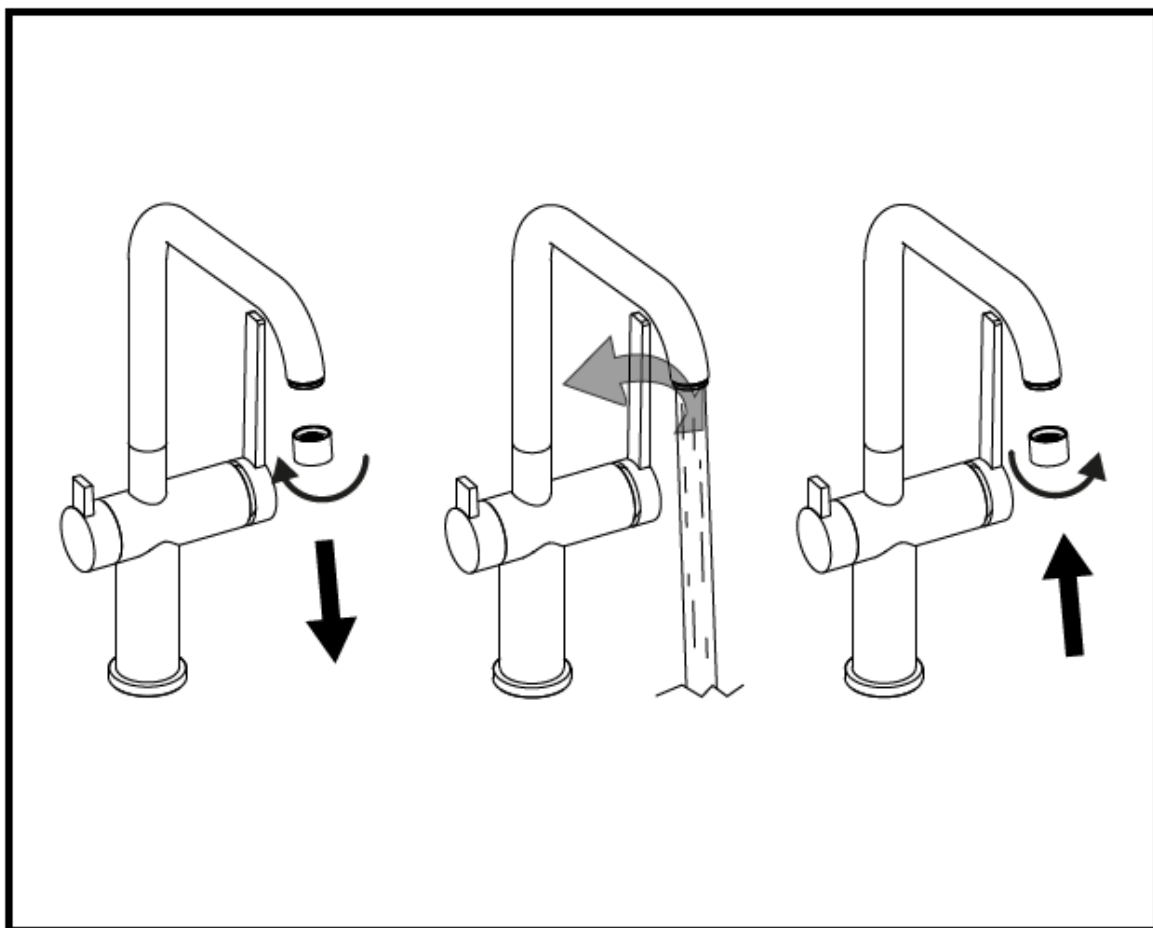

LAPETEK LINO-30

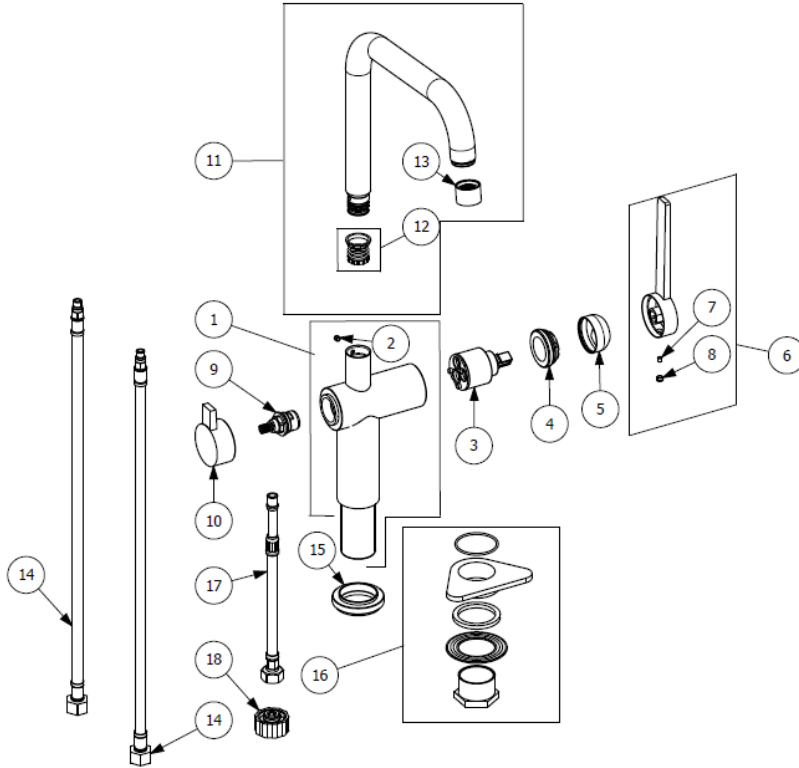

VARAOSASETTI* SET OF SPAREPARTS*	OSA NRO PART NO	TUOTE PRODUCT	OSA NRO PART NO	TUOTE PRODUCT
	1	1600224131		
	2	16002232		
	3	16000007		
160231	4	16001283	5	1600128431
	6	1600200931		
	7	16000533		
160331	9	16002355	10	1600225131
	11	1600227331		
	12	16002262		
	13	1600024131		
	14	16002354		
	15	1600218431		
	16	16000672		
160200	17	16000260	18	16002216

* sisältää samalla rivillä olevat varaosat

* Includes the parts at the same row